



REAL[®] 9000 PLUS



**INSTRUCTIONS FOR USE AND CARE
REAL 9000 PLUS/EL/ADULT/CHILD/MINI/COXIT**

Article No. 803410
Changed 130716
Valid from 070601

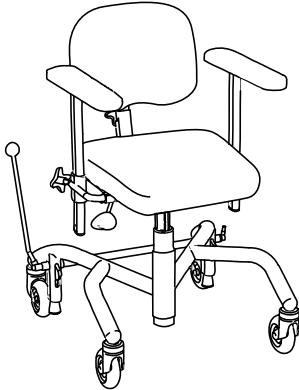

REAL PLUS

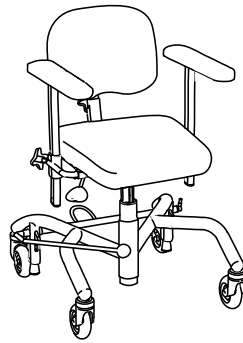

REAL PLUS CHILD/MINI

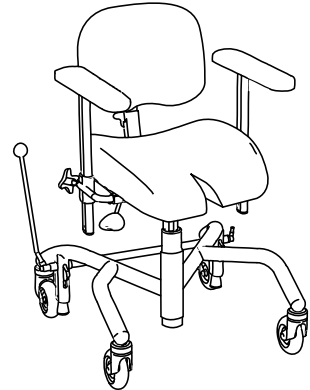

REAL PLUS COXIT

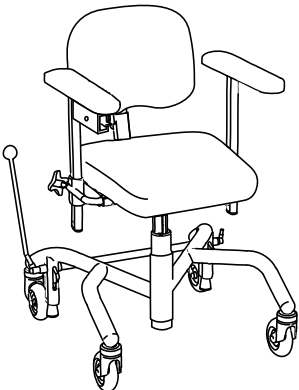

REAL PLUS EL

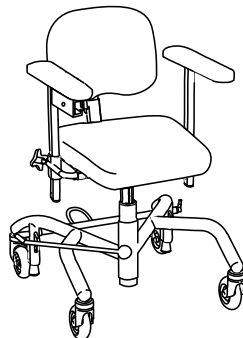

REAL PLUS CHILD/MINI EL

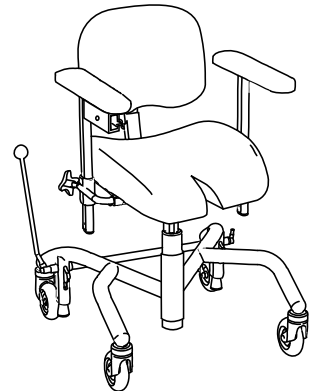

REAL PLUS COXIT EL

GET ACQUAINTED WITH YOUR REAL 9000 PLUS

PRE-USE INSPECTION CHECKLIST

1. Adjust the armrests into a suitable height by loosening the knob on the side and make sure the lever controlling the seat height is locked into its position.
2. Slide the backrest onto the designated pole and tighten the knob that allows you to alter the height of the backrest.
3. Insert the brake lever into the designated bracket (right or left side). This is not applicable for the electric brake.
4. Make sure all knobs and levers are secure and tightened before using the chair.
5. When getting in or out of the chair make sure that the brake is always applied.
6. To be able to use the electric functions; pull out the red transport safety pin, located in the charging socket (only applicable for electric chairs).
7. Charge the chair according to attached directive.



Mercado Medic AB
Tryffelslingan 14
181 57 Lidingö
Sweden

Telefon & Fax
Tel +46 8 555 143 00
Fax +46 8 555 143 99

Email & Internet
Email info@mercado.se
Internet www.mercado.se

IMPORTANT INFORMATION AND CLASS

The REAL chair has exchangeable components, accessories and functions that can be adjusted to suit individual needs. The chair should only be used by the person and for the purpose for which it was originally intended. The chair is designed for indoor use and should not be exposed to water, other fluids or chemicals nor should it be exposed to high temperatures intensive sunlight or similar. The chair may not be equipped with other accessories or components than those approved by Mercado Medic. Repairs and other technical adjustments may only be carried out by personnel authorized by Mercado Medic. Please read through these instructions carefully before using your chair.

- REAL PLUS EL is classified as protection class II, internal battery.
- REAL PLUS EL is classified as protection type B.
- REAL PLUS EL has been EMC-tested and proven in accordance with EN 60601-1-1 and EN 60601-1-2, and must therefore be used in accordance with our User and care instructions.
- An EMC supplement can be downloaded on <http://www.mercado.se/pdf/swe/3/emc.pdf>
- Mobile telephones or other RF communication equipment can interfere with the REAL PLUS EL.
- Maximum user weight: REAL PLUS 140 kg and REAL PLUS EL 150 kg.
- The chair must be transported in designated boxes on pallets, and must be stored indoors at minimum +10°C.
- Only electrical equipment from Mercado Medic AB is permitted for usage on the REAL PLUS EL.
- **Note!** The electric functions of the REAL PLUS EL-chairs may only be used at a maximum of 10% of the time (max 6 min/h). If this limit is exceeded the chair can be damaged.
- This symbol warns of the danger of crushing. 

BRAKE

NOTE! The brake should always be applied when you sit down or raise yourself from the chair. The brake should be checked regularly. The rubber brake blocks can be replaced due to wear and tear. Brake function may be insufficient on uneven surfaces.

THERE ARE THREE TYPES OF BRAKES:

Handbrake lever, footbrake and electrical brake.

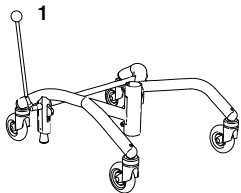

Handbrake

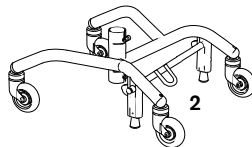

Footbrake

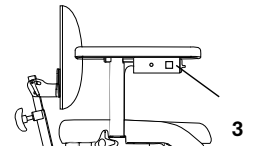

Electrical brake (optional)

CONTROL

1. Brake, PLUS-base 48: push the lever forward.
2. Brake, PLUS-base 43: pull the lever backward, pedal downward.
3. Electrical brake: push button.

SEAT HEIGHT / LIFTING DEVICE

THERE ARE TWO TYPES OF SEAT LIFTS:

Gas spring- and Electric liftomat. These are available in two different seat heights, low and standard height. The lever for the Gas spring liftomat can be placed under the seat or the armrest. On a standard design the Electric adjustment control is mounted under the armrest. **NOTE!** Light weighted people may need assistance to raise and lower their gas spring controlled chair.

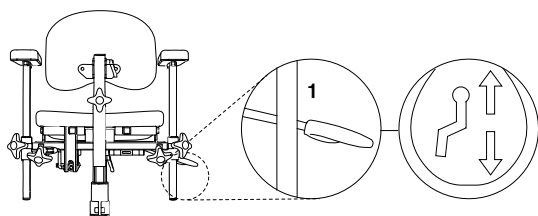

Gas spring control under seat

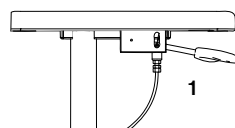

Gas spring control under armrest (optional)

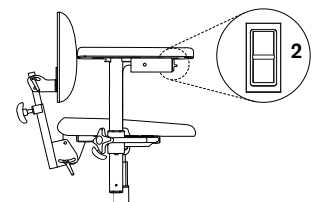

Electric controlled*

*Electric control as a free-standing control/joystick/remote control is optional

CONTROL

1. Seat height. Gas spring – pull the lever upward.
2. Seat height. Electric – push the toggle switch up/down.

SEAT TILT (OPTIONAL)

THERE ARE THREE ALTERNATIVE DESIGNS FOR ADJUSTING THE TILT OF THE SEAT:

Crank adjustment, Gas spring and Electric. The lever for the gas spring is situated either at the back left-hand edge of the seat or under the armrest. On a standard design the Electric adjustment control is mounted under the armrest.

The standard seat angle interval is $+15^{\circ}/-8^{\circ}$.

CONTROL

1. Seat tilt. Crank adjustment – turn the knob.
2. Seat tilt. Gas spring – push the lever backward.
3. Seat tilt. Gas spring – pull the lever upward.
4. Seat tilt. Electric – push the toggle switch up/down.

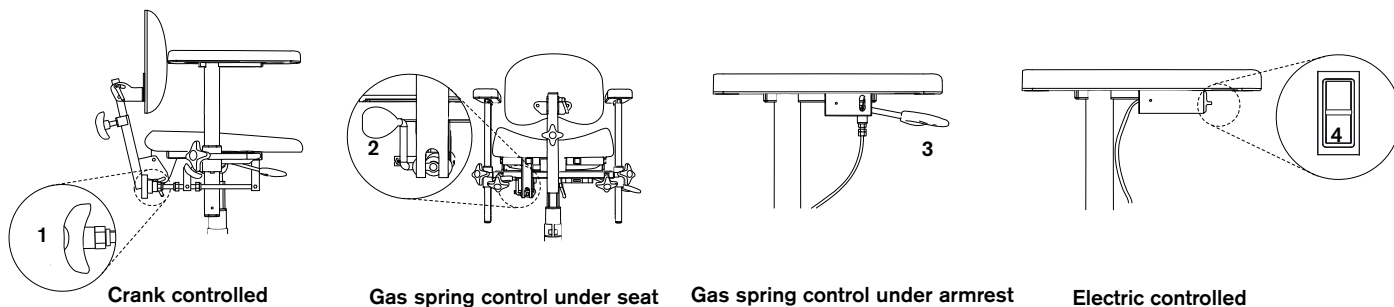

BACKREST MECHANISM

THERE ARE FOUR TYPES OF BACKREST MECHANISMS:

Standard, Medic, Comfort and Electric. All models are available in both a low and a high design (illustrated chairs show the low backrest). Everyone of the backrest mechanisms has separate controls for height, depth and angle. The Medic model has an extended depth adjustment.

CONTROL

1. Height.
2. Angle of Backrest mechanism.
3. Angle of Backrest.
4. Depth.

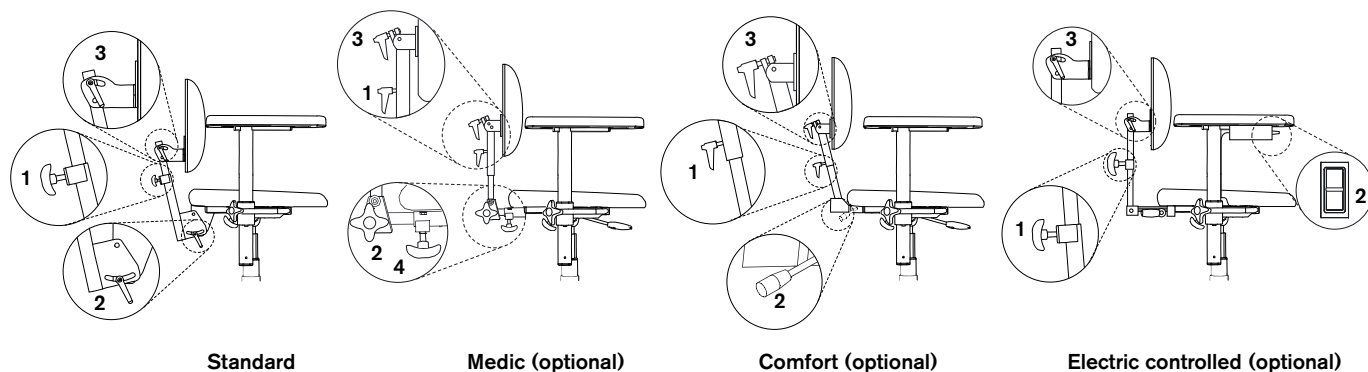

ARMREST

CONTROL

1. Height adjustment.
2. Width adjustment.
3. Tilt.

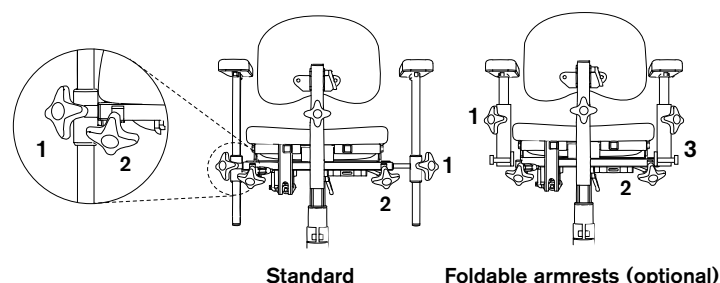

ROTATION ACCESSORY (OPTIONAL)

Note! Rotation should be in locked position when sitting down and standing up from the chair. Make sure that the lever has locked into place.

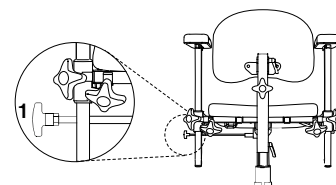

CONTROL

1. Turn clockwise to release and anti-clockwise to lock the device.

ADJUSTMENT OF THE COXIT FLAPS

REAL PLUS COXIT/EL

There are two methods for adjusting the coxite flaps. On chairs with no seat angle adjustment the controls are placed under the front edge of the seat. On chairs equipped with seat angle adjustment the controls are placed on the back edge of the seat.

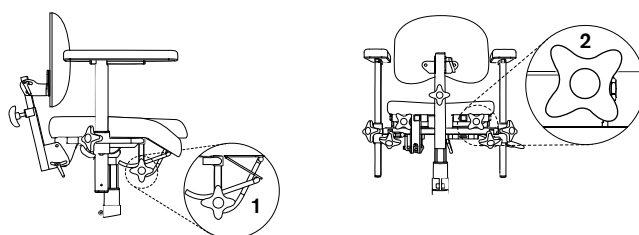

CONTROL

1. Loosen, adjust to the required angle and then tighten the knob.
2. Turn the knob to raise/lower the flap.

CLEANING, MAINTENANCE AND RECHARGING

The chair must be wiped clean and kept dirt and dust free. Clean the upholstery with foamwash; 1. Remove dirt, crumbs etc. 2. Apply a thin layer of foam, use a moist cloth to wipe the foam in an equally thick layer. 3. Swab with a clean and damp cloth. 4. Vacuum when dry. The seat, back support and other upholstered parts are not made from sealed materials for functional reasons. For hygienic reasons, whenever the upholstery is replaced, the seat and upholstery filling must also be replaced. The electric lifting device must be checked regularly for dirt, dust and stability: move the seat up to the highest position. Clean with a dry cloth. Do not use water or solvents. Lubricate the cylinder with a thin film of teflon- or silicon-based grease. Use only battery charger REAL 9000 model 2240-12V, item no. 802289 when charging the chair. If another battery charger is desired, contact Mercado Medic AB for a written approval. The battery should be charged regularly; if possible once a day. It is important that the battery is never completely discharged.

CHARGING (FOR ELECTRIC CHAIR)

Connect the charger contact (1) into the socket on the box where the toggle-switch for raising and lowering the seat is situated. Then plug in the charger (2) to the wall socket or power point. The light on the charger indicates when charging is taking place. The battery is fully charged when the LED color changes from yellow to green. Only chargers designed for

REAL-chairs may be used. The chair can be raised and lowered while charging. This regards electric chairs delivered from w. 11 2013 or earlier delivered upgraded chairs. **NOTE!** Charging the battery is particularly important for those chairs which have electric brake, electric tilt and electric backrest, because these functions require high battery capacity to work and to not lose function. Avoid this by charging once a day. When replacing battery (Model designation: HP7-12 12V 7.2Ah), make sure to that the plus battery cable is connected to the plus pole of the battery, and the minus cable to the minus pole. If the chair's electric functions stop working it is most probably due to a blown fuse. Check the fuses in the fuse holders that are located under the seat on the cable between the battery and the actuator. Replace the blown fuse with a new 25A fuse.

Pay attention to the following when handling batteries: Never short-circuit the battery. • Don't expose the battery to heavy bumps or open fires. If you come into contact with battery acid, rinse with water for 15 min. Contact a doctor. • Dead batteries must be handed in to recycling stations. Used batteries should be disposed at appropriate recycling facilities.

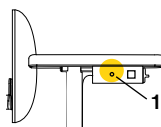

Charger art.no 802289



Mercado Medic AB
Tryffelslingan 14
181 57 Lidingö
Sweden

Telefon & Fax
Tel +46 8 555 143 00
Fax +46 8 555 143 99

Email & Internet
Email info@mercado.se
Internet www.mercado.se